



**TABE**

*We build solutions*

# Ventajas

del Breaker TABE

- ▶ Diseño cilíndrico.
- ▶ Mínimo mantenimiento.
- ▶ Estructura mono bloque en martillos de gama ligera.
- ▶ Sin tirantes en toda la gama.
- ▶ Trabajos submarinos.
- ▶ Sistema de protección contra golpes en vacío.
- ▶ Engrase automático.
- ▶ Mejor relación calidad-precio.
- ▶ Mayor vida útil.
- ▶ Servicio post venta TABE.

TABE cuenta con un laboratorio de ensayos único que prueba y garantiza la calidad, funcionamiento y resistencia de la totalidad de sus productos antes de salir al mercado.

Una de las señas de identidad de TABE, desde sus inicios y hasta hoy, es la calidad aplicada en los procesos de diseño, fabricación y, consecuentemente, de sus productos, reforzado todo ello con un esmerado servicio al cliente.

# Advantages

of the TABE Breaker

- ▶ Cylindrical design.
- ▶ Minimum maintenance.
- ▶ Light range breaker with monoblock structure.
- ▶ Through bolts free.
- ▶ Underwater work.
- ▶ Blank firing protection system.
- ▶ Autolube system.
- ▶ Best value for money.
- ▶ Longer product lifetime.
- ▶ TABE after sales service.

TABE has a unique testing laboratory that tests and guarantees the quality, performance and resistance of all its products before going on the market.

One of the hallmarks of TABE since its origins until today, is the quality applied in the processes of design, manufacture and, consequently, of its products, all reinforced with an outstanding customer service.



Obra Pública  
Public Works



Demolición  
Demolition



Minería  
Mining



## Gama Ligera · Ligth Range



Model	NEW				NEW				
	MT 65	MT 95	MT 145	MT 175	MT 195	MT 265	MT 375	MT 475	
kg	67	110	140	170	200	250	340	410	
tn	0.7-2	1-3	2-4	2,5-4,5	3-5	4-7	5-8	7-10	
l/min	15-25	20-35	20-40	35-50	35-50	50-70	55-75	60-80	
bar	100-140	100-140	100-140	90-110	120-140	100-140	120-135	120-135	
bpm	800-1.200	1000-1.400	850-1.200	875-1.200	875-1.200	850-1.200	725-950	750-975	
mm	37	50	55	50	65	65	65	84	
mm	435	530	450	450	610	610	610	700	
mm	846	1.000	940	1.050	1.145	1.200	1.270	1.335	
S	S	-	-	-	S	S	S	S	
0	0	0	0	0	0	0	0	0	

## Gama Media · Medium Range



Model	NEW			NEW	
	MT 575	MT 800	MT 10	MT 12	MT 15
kg	600	760	950	1250	1470
tn	9-12	11-14	13-16	15-23	18-23
l/min	90-120	70-125	85-110	90-120	120-140
bar	120-135	120-160	150-170	150-170	150-170
bpm	750-950	500-875	500-665	400-800	450-750
mm	90	105	105	120	135
mm	900	1.000	1.000	1.100	1.100
mm	1.670	1.860	1.860	2.100	2.260
S	S	S	S	S	S
0	0	0	S	S	S
0	0	0	S	S	S
-	-	-	0	0	S
β	0	0	0	0	0

## Gama pesada · Heavy range



Model	MT 18	MT 20	MT 30	MT 40	MT 80
kg	1950	2300	3300	4850	7900
tn	22-26	25-35	30-45	42-65	60-100
l/min	130-145	180-210	205-245	250-340	300-400
bar	160-180	160-180	160-180	160-180	160-180
bpm	470-620	350-600	300-550	290-557	280-330
mm	135	150	165	180	215
mm	1.100	1.320	1.525	1.625	1.880
mm	2.500	2.500	2.800	3.000	3.640
S	S	S	S	S	-
S	S	S	S	S	S
S	S	S	S	S	S
S	S	S	S	S	S
β	0	0	0	0	0

- Sistema pare  
Blank firing protection System
- Circuito engrase automático  
Auto lube circuit
- Sist. trabajos submarinos  
Underwater system
- Variación de frecuencia  
Frequency variation
- Sistema de auto-engrase  
Auto lube
- S** Incluido / Included
- 0** Opcional / Optional

# Características *Features*

**MT 65**

**MT 265**

**MT 95**

**MT 375**

**MT 145**

**MT 575**

**MT 175**

**MT 800**

**MT 195**

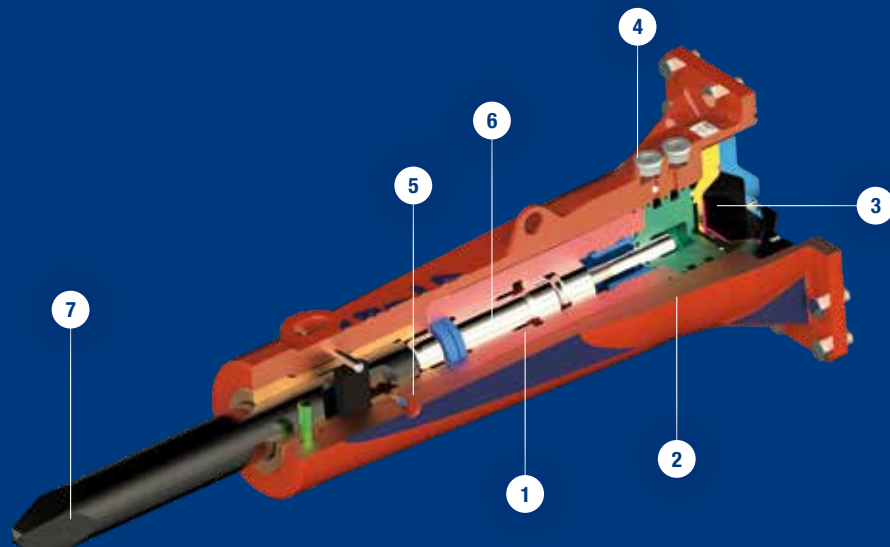

1. Ausencia de tirantes en toda la gama.
2. Cuerpo con diseño cilíndrico de alta resistencia.
3. Recuperación de energía, tecnología híbrida.
4. Opcional: sistema para trabajos submarinos.
5. Sistema de engrase.
6. Sólo dos partes en movimiento.
7. Gama completa de punteros para diferentes aplicaciones.

1. *Through bolts free.*
2. *Cylindrical design with high hardness casting body.*
3. *Energy recovery, hybrid technology.*
4. *Optional: underwater working system.*
5. *Greasing system.*
6. *Only two parts in movement.*
7. *Wide range of tools for different applications.*

**MT 10**

**MT 20**

**MT 12**

**MT 30**

**MT 15**

**MT 40**

**MT 18**

**MT 80**

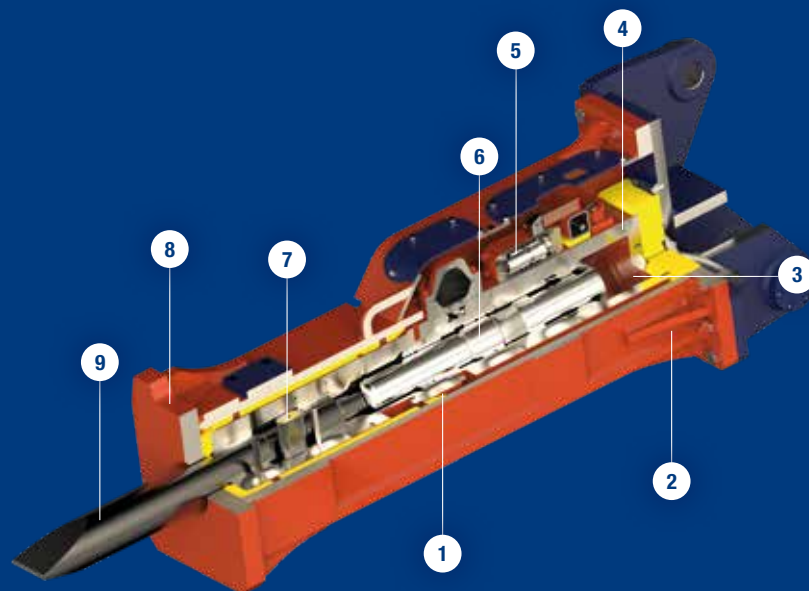

1. Ausencia de tirantes en toda la gama.
2. Carcasa más robusta con aislamiento de alta densidad.
3. Recuperación de energía, tecnología híbrida.
4. Trabajos submarinos.
5. Sistema de engrase Auto lube centralizado.
6. Sólo dos partes en movimiento.
7. Doble retenedor de puntero.
8. Carcasa reforzada con material anti desgaste.
9. Gama completa de punteros para diferentes aplicaciones.

1. *Through bolts free.*
2. *Solid housing with high density isolation.*
3. *Energy Recovery, Hybrid technology.*
4. *Underwater working system.*
5. *Auto lube system.*
6. *Two moving parts only.*
7. *Double tool retainer.*
8. *Reinforced housing with wear-resistant material.*
9. *Wide range of tools for different applications.*

### Características generales:

- ▶ Ausencia total de tirantes.
- ▶ Cuerpo con diseño cilíndrico de alta resistencia.
- ▶ Recuperación de energía, tecnología híbrida.
- ▶ Alta energía de impacto.
- ▶ Gama completa de punteros para diferentes aplicaciones.
- ▶ Sistema de protección contra golpes en vacío.
- ▶ Especialmente concebido para obtener la mejor relación peso-potencia.



### Technical features:

- ▶ Through bolts free.
- ▶ Cylindrical design with high hardness steel body.
- ▶ Energy recovery, hybrid technology.
- ▶ High impact energy.
- ▶ Wide range of tools for different applications.
- ▶ Blank firing protection system.
- ▶ Especially designed to achieve the best power to weight ratio.

Model	MT65	
	kg	67
	tn	0.7-2
	l/min	15-25
	bar	100-140
	bpm	800-1.200
	mm	37
	mm	435
	mm	846
		S
		0

### Características generales:

- ▶ Ausencia total de tirantes.
- ▶ Cuerpo con diseño cilíndrico de alta resistencia.
- ▶ Recuperación de energía, tecnología híbrida.
- ▶ Alta energía de impacto.
- ▶ Gama completa de punteros para diferentes aplicaciones.
- ▶ Sistema de protección contra golpes en vacío.
- ▶ Especialmente concebido para obtener la mejor relación peso-potencia.



### Technical features:

- ▶ Through bolts free.
- ▶ Cylindrical design with high hardness steel body.
- ▶ Energy recovery, hybrid technology.
- ▶ High impact energy.
- ▶ Wide range of tools for different applications.
- ▶ Blank firing protection system.
- ▶ Especially designed to achieve the best power to weight ratio.

Model	MT 195	
	kg	200
	tn	3-5
	l/min	35-50
	bar	120-140
	bpm	875-1.200
	mm	65
	mm	610
	mm	1.145
		S
		0

# MT 800

NEW













## Características generales:

- ▶ Ausencia total de tirantes.
- ▶ Cuerpo con diseño cilíndrico de alta resistencia.
- ▶ Recuperación de energía, tecnología híbrida.
- ▶ Alta energía de impacto.
- ▶ Gama completa de punteros para diferentes aplicaciones.
- ▶ Sistema de protección contra golpes en vacío.
- ▶ Especialmente concebido para obtener la mejor relación peso-potencia.



## Technical features:

- ▶ Through bolts free.
- ▶ Cylindrical design with high hardness steel body.
- ▶ Energy recovery, hybrid technology.
- ▶ High impact energy.
- ▶ Wide range of tools for different applications.
- ▶ Blank firing protection system.
- ▶ Especially designed to achieve the best power to weight ratio.

Model	MT 800	
	kg	760
	tn	11-14
	l/min	70-125
	bar	120-160
	bpm	500-875
	mm	105
	mm	1.000
	mm	1.860
		S
		0
		0
		0

# MT 12

NEW













## Características generales:

- ▶ Ausencia total de tirantes.
- ▶ Carcasa más robusta con aislamiento de alta densidad.
- ▶ Recuperación de energía, tecnología híbrida.
- ▶ Alta energía de impacto.
- ▶ Gama completa de punteros para diferentes aplicaciones.
- ▶ Sistema de protección contra golpes en vacío.
- ▶ Especialmente concebido para obtener la mejor relación peso potencia.



## Technical features:

- ▶ Through bolts free.
- ▶ Solid housing with high density isolation.
- ▶ Energy recovery, hybrid technology.
- ▶ High impact energy.
- ▶ Wide range of tools for different applications.
- ▶ Blank firing protection system.
- ▶ Especially designed to achieve the best power to weight ratio.

Model	MT 12	
	kg	1250
	tn	15-23
	l/min	90-120
	bar	150-170
	bpm	400-800
	mm	120
	mm	1.100
	mm	2.100
		S
		S
		S
		0
		0

# Betasystem

Sistema de auto-engrase

Auto lube system

## Características generales:

- ▶ Diseñado para un perfecto engrase permanente.
- ▶ Reduce los desgastes y evita averías prematuras.
- ▶ Elimina los tiempos muertos por mantenimiento preventivo.
- ▶ Especialmente diseñado para los siguientes modelos:

- MT 575	- MT 18
- MT 800	- MT 20
- MT 10	- MT 30
- MT 12	- MT 40
- MT 15	- MT 80



## Main features:

- ▶ Designed for a perfect permanent lubrication.
- ▶ It reduces wear and prevents from premature breakdowns.
- ▶ It avoids preventive maintenance downtime.
- ▶ Especially designed for the following models:

- MT 575	- MT 18
- MT 800	- MT 20
- MT 10	- MT 30
- MT 12	- MT 40
- MT 15	- MT 80

## Soluciones

para cada aplicación

TABE diseña y fabrica una completa gama de punteros especialmente concebidos para obtener el mejor rendimiento en todas las aplicaciones especiales de hincado de postes, vallas, pilotes...

## Solutions

for each application

TABE designs and manufactures a wide range of tools especially conceived to achieve the best performance. Tools designed for pile driving, fenced, rail driving...

**PICA PRISMA**  
**MOIL TOOL**



**PICA CINCEL**  
**CHISEL TOOL**



**PICA CONICA**  
**POINT TOOL**



**PICA PLANA**  
**BLUNT TOOL**



**PICA PALA**  
**WIDE CHISEL TOOL**



**PATA DE ELEFANTE**  
**ELEPHANT TOOL**



**PICA HINCA POSTES**  
**POST HOLE DRIVER**



**PICA HINCA RAILES**  
**RAMMING TOOL**



Distribuidor Autorizado  
Authorized dealer



Suretech House, 48 Jawahar Industrial Area, Kamothe, Panvel, Navi Mumbai 410209  
Toll free: 1800 120 7873 Customer Relations: +91 77388 94923 Sales: +91 70213 26765  
Email: sales@suretech.co.in www.suretechinfra.com YouTube: www.youtube.com/SURETECH



The specifications, photographs and diagrams of the models represented in this catalogue are included for informative purposes only and may not be used as a basis for claims. Talleres Betoño S.A. reserves the right to make any changes if it is necessary without prior notice. Catalogue 2021/2EN

Since 1968  
building solutions